



[www.nitromac.com](http://www.nitromac.com)





NITROMAC was established in 2011 to design, manufacture and sell service equipment for automotive industry including;

- Hydraulic Rim Repair Machines
- Rim Cleaning and Polishing Machines
- Wheel Alignments
- Tyre Changers
- Wheel Balancers
- Hydraulic Platform Lifts
- Headlight Testers
- Nitrogen Inflators

With its young, experienced and dedicated personnel; Nitromac's mission is to supply the highest quality designed and patented under car equipment with high manufacturing technology available.

From premises located in Izmir/ Turkey, company exports %80 of its production to 56 countries in regular basis and 62 countries in total.

Nitromac has CE, ISO 9001:2008, OHSAS 18001 certificates and 4 different type of rim repair machine patents.



## INDEX

<b>WHEEL ALIGNMENT</b>	<b>6</b>
<b>RIM STRAIGHTENING MACHINES</b>	<b>14</b>
<b>RIM CLEANING AND POLISHING MACHINES</b>	<b>52</b>
<b>HYDRAULIC PLATFORM LIFTS</b>	<b>54</b>
<b>HEADLIGHT TESTERS</b>	<b>68</b>
<b>NITROGEN</b>	<b>70</b>
<b>TYRE CHANGERS</b>	<b>71</b>
<b>WHEEL BALANCERS</b>	<b>90</b>
<b>AIR COMPRESSORS</b>	<b>98</b>
<b>FAIRS</b>	<b>101</b>
<b>CERTIFICATES</b>	<b>106</b>

# WA3020 PRO

## NEW GENERATION 3D WHEEL ALIGNMENT SYSTEM

### Specifications:

- High speed precise wheel alignment
- Windows 10 operating system
- Standard 44.000 vehicles data base
- Standard wireless remote control to control all setting
- 3D real-time measurement and reporting with printer



## BENEFITS

- Clear wide-angle professional camera eliminates the need for elevator
- Precise measurement up to 16 meters distance thanks to high resolution (fast and clear measurement of long chassis vehicles such as Sprinter, Crafter, Master)
- Gives the best results without being affected by daylight
- Cross measurement and vehicle chassis alignment measurement capability
- Animated display of all vehicle information (Rot setting features, tire pressure details, 3D animated graphics)
- Auto data and Nitromac data base to update vehicle information at the same time on all devices around the world.
- Ability to manually add and save unlimited vehicle model and factory values, store in memory by uploading customer information
- Option to reflect the screen on tablets and mobile devices as an option
- Always be able to adjust steering angle without error
- Double-tie clamps can be used to attach the rim cover to the tire without removing it
- Optional web cam and light guidance for safe access to the station
- High quality graphics for precise and sharp adjustment
- 3 different measurement methods, program type selection, standard, fast or free choice
- 5 years free data base update with Key Card

## STANDARD ACCESSORIES

- Camera column
- Cabin
- 32" LCD screen
- Fast computer unit with Windows 10 operating system
- Anti shock targets
- 4 Multi-fit connection clamps
- Steering lock
- Brake locking device
- Mechanical rotary table
- Inkjet printer
- Wireless remote control
- Wifi

## OPTIONAL ACCESSORIES

- Web cam
- LED warning panel
- Tablet connection system
- Optional LCD multi-screen
- Mechanical sliding table

# TECHNOVECTOR 7 TRUCK

3D Wheel Aligners



**BENEFITS**

- Clear wide-angle professional camera eliminates the need for elevator
- Precise measurement up to 16 meters distance thanks to high resolution (fast and clear measurement of long chassis vehicles such as Sprinter, Crafter, Master)
- Gives the best results without being affected by daylight
- Cross measurement and vehicle chassis alignment measurement capability
- Animated display of all vehicle information (Rot setting features, tire pressure details, 3D animated graphics)
- Auto data and Nitromac data base to update vehicle information at the same time on all devices around the world.
- Ability to manually add and save unlimited vehicle model and factory values, store in memory by uploading customer information
- Option to reflect the screen on tablets and mobile devices as an option
- Always be able to adjust steering angle without error
- Double-tie clamps can be used to attach the rim cover to the tire without removing it without removing it
- Optional web cam and light guidance for safe access to the station
- High quality graphics for precise and sharp adjustment
- 3 different measurement methods, program type selection, standard, fast or free choice
- 5 years free data base update with Key Card

**STANDARD ACCESSORIES**

- Camera column
- Cabin
- 32" LCD screen
- Fast computer unit with Windows 10 operating system
- Anti shock targets
- 4 Multi-fit connection clamps
- Steering lock
- Brake locking device
- Mechanical rotary table
- Inkjet printer
- Wireless remote control
- Wifi

**OPTIONAL ACCESSORIES**

- Web cam
- LED warning panel
- Tablet connection system
- Optional LCD multi-screen
- Mechanical sliding table



# TECHNOVECTOR 8



**BENEFITS**

**Contactless wheel aligner for the pit**

- Contactless measurement and adjustment
- Measures cars with wheelbases from 2 up to 3.5m \*\* (from 80 inches up to 135 inches)
- Automatically rotating rear posts that are adaptive for different wheelbases
- Installation of wheel adapters or any other equipment on wheels is not required

**Machine vision systems**

- Measuring in a matter of seconds;
  - Precise industrial cameras;
  - Structured light projection systems;
  - 3D scanning of each wheel in real-time;
- Posts of the machine vision systems
- Posts are equipped with the machine vision systems and projection system;
  - Robust design;
  - Posts can be adapted for individual features of your workplace;
  - Rotating mechanism allows measuring cars with different length without moving the posts sideways.

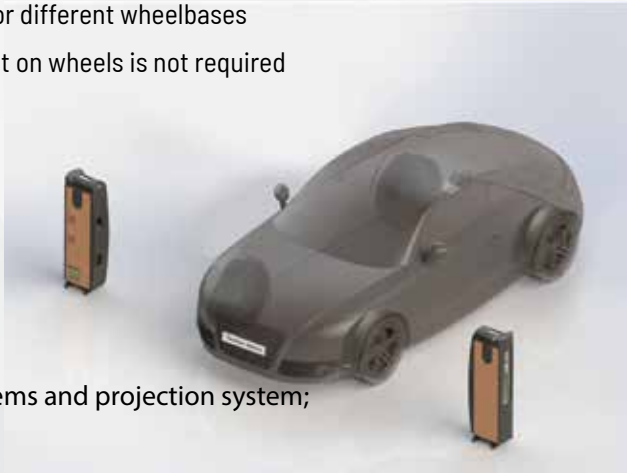

**Utilizes the MOTOR Driven™ database**

- The software utilizes the latest version of the complete US local market vehicle MOTOR Driven™ database;
- The choice of a vehicle model by its VIN eliminates operator error when choosing a specification;
- New illustrated OEM instructions for adjustment procedures;
- A new VIN bar-code reader time-saver option is available.



# BALLOON JACK

## Specifications:

- High speed precise wheel alignment
- Windows 10 operating system
- Standard 44.000 vehicles data base
- Standard wireless remote control to control all settings
- 3D real-time measurement and reporting with printer



**TECHNICAL SPECIFICATIONS**

Capacity	2000kg
Lifting height	530mm
Minimum height	110mm
Lifting time	16 sec



# RIM REPAIR / CLEANING AND POLISHING MACHINES

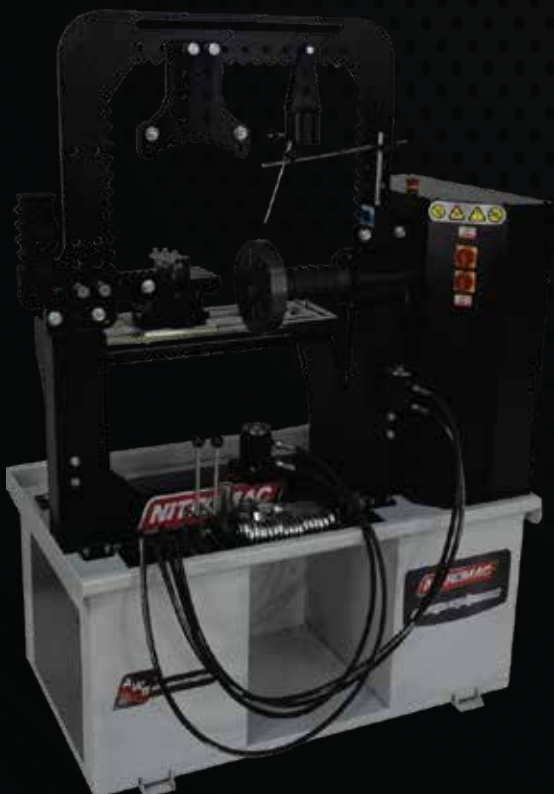
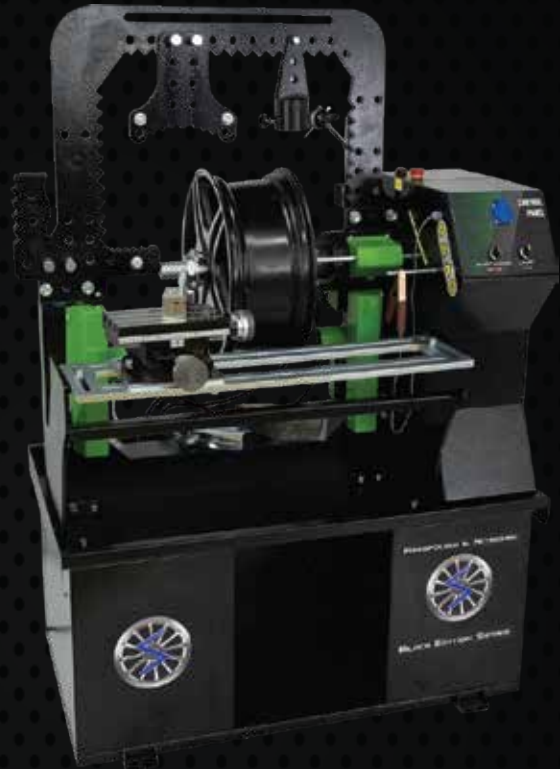

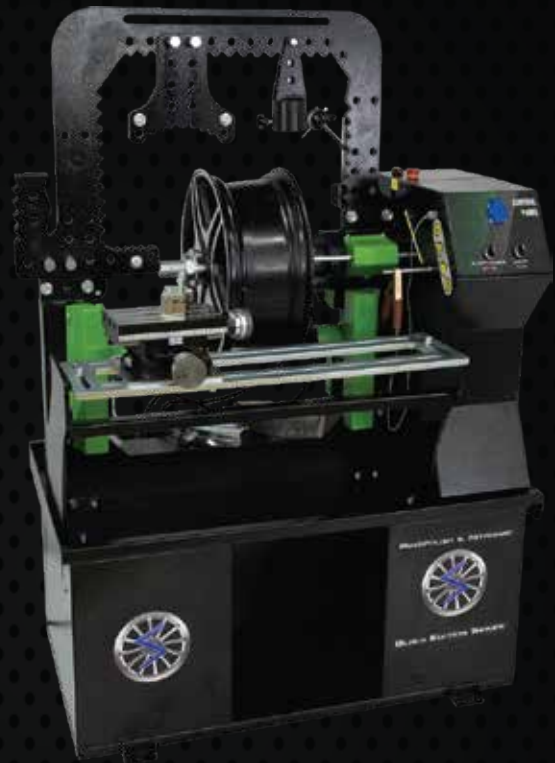

# ROBOPRO

## 10"30" Electrohydraulic Rim Straightening Machine



### Specifications:

- Laser Measure
- X,Y,Z way full automatic electrohydraulic joystick controller
- Industrial Touch Pannel Screen
- Working Light
- Adjustable Thermometer
- Speed Control System



**TECHNICAL SPECIFICATIONS**

Rim Diameters	10" - 30"
Hydraulic Engine	6 cylinder full automatic
Mechanic Engine	hydraulic joystick controller
3 phase - single phase	2,2kw hydraulic motor
Length	1,1 kw mechanic motor
Width	2200mm
Height	1000mm
Weight	1700mm
Hydraulic Pump Power	760kg
	5 ton

**STANDARD ACCESSORIES**



**DH120**  
Digital  
Thermometer



**SCU 435**  
Speed Control  
Unit



**HFM 250**  
2pcs  
Halfmoon Set



**GLPEN**  
Gold Lathe Pen



1pc Manual Head  
Repair Tool



3pcs  
Lengthening  
Tools



**MMP90**  
Magnetic Gauge  
Tool Holder



5pcs Bolt, Nut  
and Conical  
Adapter Set

# RS28 TAB WL PRO

10" - 28" PRO RIM STRAIGHTENING  
MACHINE WITH LATHE AND  
TABLET CONTROL SYSTEM

## Specifications:

Optional Tablet System



**TECHNICAL SPECIFICATIONS**

Rim Diameters	10" - 28"
Hydraulic Engine	0,55kW 900 d/d rpm 1h
Mechanic Engine	0,55kW 900 d/d rpm 1h
3 phase - single phase	380V -(optional 220V)
Length	1200mm
Width	800mm
Height	1600mm
Weight	440kg
Hydraulic Pump Power	5 ton



**STANDARD ACCESSORIES**



**DH120**  
Digital  
Thermometer



**SCU 435**  
Speed Control  
Unit



**HFM 250**  
2pcs  
Halfmoon Set



**GLPEN**  
Gold Lathe Pen



1pc Manual Head  
Repair Tool



3pcs  
Lengthening  
Tools



**MMP90**  
Magnetic Gauge  
Tool Holder



**PLUG220**  
220V Electric  
Plug Output



Plastic Tool  
Holder



5pcs Bolt, Nut  
and Conical  
Adapter Set



1 Set  
Lathe Tool



5pcs  
Straightening  
Heads



1 Set  
Piston Holder  
Adapter



2pcs  
Allen Keys



1pc  
Manuel Gauge  
Tool



18pcs  
Rim Centering  
Adapters

# F24 WL PRO

10" - 24" PRO RIM STRAIGHTENING  
MACHINE WITH LATHE

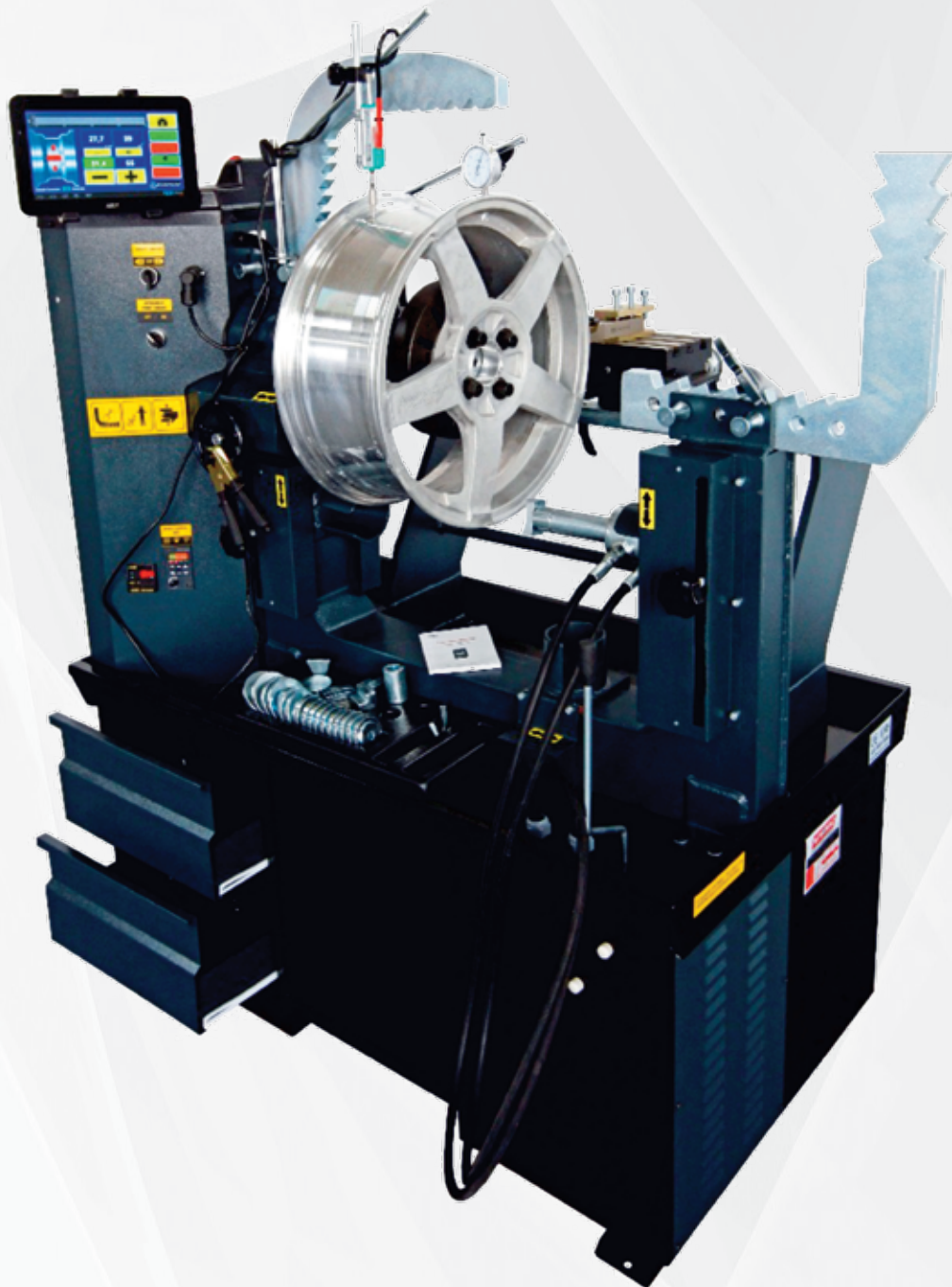

**TECHNICAL SPECIFICATIONS**

Rim Diameters	10" - 24"
Hydraulic Engine	0,55kW 900 d/d rpm 1h
Mechanic Engine	0,55kW 900 d/d rpm 1h
3 phase - single phase	380V -(optional 220V)
Length	1200mm
Width	800mm
Height	1600mm
Weight	400kg
Hydraulic Pump Power	5 ton

**STANDARD ACCESSORIES**



**HFM 250**  
2 pcs  
Halfmoon Set



**GLPEN**  
Gold Lathe Pen



1pc Manual Head  
Repair Tool



3pcs  
Lengthening  
Tools



1pc  
Manuel Gauge  
Tool



18pcs  
Rim Centering  
Adapters



Plastic Tool  
Holder



5pcs Bolt, Nut  
and Conical  
Adapter Set



1 Set  
Lathe Tool



5pcs  
Straightening  
Heads



1 Set  
Piston Holder  
Adapter



2pcs  
Allen Keys

# F24 WL

10" - 24"  
RIM STRAIGHTENING MACHINE  
WITH LATHE

Optional  
Additional Frame  
Adapter Set



**TECHNICAL SPECIFICATIONS**

Rim Diameters	10" - 24"
Hydraulic Engine	0,55kW 900 d/d rpm 1h
Mechanic Engine	0,55kW 900 d/d rpm 1h
3 phase - single phase	380V -(optional 220V)
Length	1200mm
Width	800mm
Height	1600mm
Weight	350kg
Hydraulic Pump Power	5 ton



**STANDARD ACCESSORIES**

- 

Plastic Tool Holder
- 

1pc Manual Head Repair Tool
- 

3pcs Lengthening Tools
- 

1pc Manuel Gauge Tool
- 

18pcs Rim Centering Adapters
- 

1 Set Lathe Tool
- 

5pcs Bolt, Nut and Conical Adapter Set
- 

5pcs Straightening Heads
- 

1 Set Piston Holder Adapter
- 

2pcs Allen Keys



# F24

10" - 24"  
RIM STRAIGHTENING MACHINE



**TECHNICAL SPECIFICATIONS**

Rim Diameters	10" - 24"
Hydraulic Engine	0,55kW 900 d/d rpm 1h
Mechanic Engine	0,55kW 900 d/d rpm 1h
3 phase - single phase	380V -(optional 220V)
Length	1200mm
Width	800mm
Height	1600mm
Weight	280kg
Hydraulic Pump Power	5 ton



**STANDARD ACCESSORIES**



Plastic Tool Holder

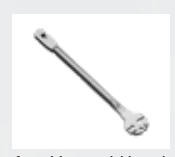

1pc Manual Head Repair Tool



3pcs Lengthening Tools



1pc Manuel Gauge Tool



18pcs Rim Centering Adapters



5pcs Bolt, Nut and Conical Adapter Set



5pcs Straightening Heads



1 Set Piston Holder Adapter



2pcs Allen Keys



# F28 WL PRO

10" - 28" PRO RIM STRAIGHTENING  
MACHINE WITH LATHE



RIM STRAIGHTENING MACHINES

NITROMAC

**TECHNICAL SPECIFICATIONS**

Rim Diameters	10" - 28"
Hydraulic Engine	0,55kW 900 d/d rpm 1h
Mechanic Engine	0,55kW 900 d/d rpm 1h
3 phase - single phase	380V -(optional 220V)
Length	1200mm
Width	800mm
Height	1600mm
Weight	480kg
Hydraulic Pump Power	5 ton



**OH650**  
Pro Type  
Top Frame  
Adapter



**GVS660**  
Hydraulic Gear  
Valve Set With  
4 Cylinder



**HFM850**  
Steel Halfmoon  
Repair Adapter  
Set 8pcs



**MMP120**  
Magnetic Gauge



**PLUG220**  
220V Electric  
Plug Output

**STANDARD ACCESSORIES**



**DH120**  
Digital  
Thermometer



**SCU 435**  
Speed Control  
Unit



**HFM 250**  
2pcs  
Halfmoon Set



**GLPEN**  
Gold Lathe Pen



1pc Manual Head  
Repair Tool



3pcs  
Lengthening  
Tools



**MMP90**  
Magnetic Gauge  
Tool Holder



Plastic Tool  
Holder



5pcs Bolt, Nut  
and Conical  
Adapter Set



**Easy 40**  
Easy  
Rim Connecting  
Adapter



18pcs  
Rim Centering  
Adapters



1 Set  
Lathe Tool



5pcs  
Straightening  
Heads



2pcs  
Allen Keys



1pc  
Manuel Gauge  
Tool



**HS280**  
Infrared Heating  
System

# RS26 WL

10" - 26"  
RIM STRAIGHTENING MACHINE  
WITH LATHE



**TECHNICAL SPECIFICATIONS**

Rim Diameters	10" - 26"
Hydraulic Engine	0,55kW 900 d/d rpm 1h
Mechanic Engine	0,55kW 900 d/d rpm 1h
3 phase - single phase	380V -(optional 220V)
Length	1200mm
Width	800mm
Height	1600mm
Weight	280kg
Hydraulic Pump Power	5 ton

**STANDARD ACCESSORIES**



Plastic Tool Holder



1pc Manual Head Repair Tool



3pcs Lengthening Tools



1pc Manuel Gauge Tool



18pcs Rim Centering Adapters



5pcs Bolt, Nut and Conical Adapter Set



1 Set Lathe Tool



5pcs Straightening Heads



1 Set Piston Holder Adapter



2pcs Allen Keys

# RS28 WL

10" - 28"  
RIM STRAIGHTENING MACHINE  
WITH LATHE



**TECHNICAL SPECIFICATIONS**

Rim Diameters	10" - 28"
Hydraulic Engine	0,55kW 900 d/d rpm 1h
Mechanic Engine	0,55kW 900 d/d rpm 1h
3 phase - single phase	380V -(optional 220V)
Length	1200mm
Width	800mm
Height	1600mm
Weight	400kg
Hydraulic Pump Power	5 ton

**STANDARD ACCESSORIES**



Plastic Tool Holder



1pc Manual Head Repair Tool



3pcs Lengthening Tools



1pc Manuel Gauge Tool



18pcs Rim Centering Adapters



5pcs Bolt, Nut and Conical Adapter Set



1 Set Lathe Tool



5pcs Straightening Heads



1 Set Piston Holder Adapter



2pcs Allen Keys

# RS28 WP

10" - 34"

RIM STRAIGHTENING MACHINE  
WITH POLISHING SYSTEM



**TECHNICAL SPECIFICATIONS**

Rim Diameters	10" - 34"
Hydraulic Engine	0,55kW 900 d/d rpm 1h
Mechanic Engine	0,55kW 900 d/d rpm 1h
3 phase - single phase	380V -(optional 220V)
Length	1200mm
Width	800mm
Height	1600mm
Weight	520kg
Hydraulic Pump Power	5 ton

**STANDARD ACCESSORIES**



Plastic Tool Holder



1pc Manual Head Repair Tool



3pcs Lengthening Tools



1pc Manuel Gauge Tool



18pcs Rim Centering Adapters



**SCU 435**  
Speed Control Unit



5pcs Bolt, Nut and Conical Adapter Set



1 Set Lathe Tool



5pcs Straightening Heads



1 Set Piston Holder Adapter



2pcs Allen Keys

# RS30 WL

10" - 30"  
RIM STRAIGHTENING MACHINE  
WITH LATHE



**TECHNICAL SPECIFICATIONS**

Rim Diameters	10" - 30"
Hydraulic Engine	0,55kW 900 d/d rpm 1h
Mechanic Engine	0,55kW 900 d/d rpm 1h
3 phase - single phase	380V -(optional 220V)
Length	1200mm
Width	800mm
Height	1600mm
Weight	430kg
Hydraulic Pump Power	5 ton



**OH650**  
Pro Type  
Top Frame  
Adapter



**GVS560**  
Hydraulic Gear  
Valve Set With  
3 Cylinder



**HFM850**  
Steel Halfmoon  
Repair Adapter  
Set 8pcs



**MMP120**  
Magnetic Gauge



**PLUG220**  
220V Electric  
Plug Output

**STANDARD ACCESSORIES**



**DH120**  
Digital  
Thermometer



**SCU 435**  
Speed Control  
Unit



**HFM 250**  
2pcs  
Halfmoon Set



**GLPEN**  
Gold Lathe Pen



1pc Manual Head  
Repair Tool



3pcs  
Lengthening  
Tools



**MMP90**  
Magnetic Gauge  
Tool Holder



Plastic Tool  
Holder



5pcs Bolt, Nut  
and Conical  
Adapter Set



**Easy 40**  
Easy  
Rim Connecting  
Adapter



18pcs  
Rim Centering  
Adapters



1 Set  
Lathe Tool



5pcs  
Straightening  
Heads



2pcs  
Allen Keys



1pc  
Manuel Gauge  
Tool



**HS280**  
Infrared Heating  
System

# RS34 WP

10" - 34"  
RIM STRAIGHTENING MACHINE  
WITH POLISHING SYSTEM



RIM STRAIGHTENING MACHINES

**TECHNICAL SPECIFICATIONS**

Rim Diameters	10" - 34"
Hydraulic Engine	0,55kW 900 d/d rpm 1h
Mechanic Engine	0,55kW 900 d/d rpm 1h
3 phase - single phase	380V -(optional 220V)
Length	1200mm
Width	800mm
Height	1600mm
Weight	400kg
Hydraulic Pump Power	5 ton

**STANDARD ACCESSORIES**



Plastic Tool Holder



1pc Manual Head Repair Tool



3pcs Lengthening Tools



1pc Manuel Gauge Tool



18pcs Rim Centering Adapters



**SCU 435** Speed Control Unit



5pcs Bolt, Nut and Conical Adapter Set



1 Set Lathe Tool

# F26 WP

10" - 30"  
RIM STRAIGHTENING MACHINE  
WITH POLISHING SYSTEM



**TECHNICAL SPECIFICATIONS**

Rim Diameters	10" - 30"
Hydraulic Engine	0,55kW 1400 d/d rpm 1h
Mechanic Engine	0,75kW 1400 d/d rpm 1h
3 phase - single phase	380V -(optional 220V)
Polishing Engine	2,2 W 3000 rpm
Rims Speed	Digital Speed Controlled 0-300rpm
Length	1500mm
Width	800mm
Height	1600mm
Weight	465kg
Hydraulic Pump Power	5 ton

**STANDARD ACCESSORIES**



Plastic Tool Holder



1pc Manual Head Repair Tool



3pcs Lengthening Tools



1pc Manuel Gauge Tool



18pcs Rim Centering Adapters



**SCU 435**  
Speed Control Unit



5pcs Bolt, Nut and Conical Adapter Set



Polishing Disc and Cream Medium Type



5pcs Straightening Heads



1 Set Piston Holder Adapter



2pcs Allen Keys

# F30 WP

10" - 30"  
RIM STRAIGHTENING MACHINE  
WITH POLISHING SYSTEM



**TECHNICAL SPECIFICATIONS**

Rim Diameters	10" - 30"
Hydraulic Engine	0,55kW 1400 d/d rpm 1h
Mechanic Engine	0,75kW 1400 d/d rpm 1h
3 phase - single phase	380V -(optional 220V)
Polishing Engine	2,2 W 3000 rpm
Rims Speed	Digital Speed Controlled 0-300rpm
Length	1500mm
Width	800mm
Height	1600mm
Weight	465kg
Hydraulic Pump Power	5 ton

**STANDARD ACCESSORIES**



Plastic Tool Holder



1pc Manual Head Repair Tool



3pcs Lengthening Tools



1pc Manuel Gauge Tool



18pcs Rim Centering Adapters



**SCU 435**  
Speed Control Unit



5pcs Bolt, Nut and Conical Adapter Set



Polishing Disc and Cream Medium Type



5pcs Straightening Heads



1 Set Piston Holder Adapter



2pcs Allen Keys

# SMART REPAIR 22

10" - 22"  
RIM STRAIGHTENING MACHINE



**TECHNICAL SPECIFICATIONS**

Rim Diameters	10" - 22"
Hydraulic Engine	0,55kW 900 d/d rpm 1h
Mechanic Engine	NOT INCLUDED
3 phase - single phase	380V -(optional 220V)
Length	1100mm
Width	500mm
Height	1400mm
Weight	140kg
Hydraulic Pump Power	5 ton

**STANDARD ACCESSORIES**



Plastic Tool Holder



1pc Manual Head Repair Tool



3pcs Lengthening Tools



1pc Manuel Gauge Tool



18pcs Rim Centering Adapters



1 Set Piston Holder Adapter



2pcs Allen Keys



5pcs Bolt, Nut and Conical Adapter Set

**NOT INCLUDED**



1 Set Lathe Tool



5pcs Straightening Heads

# SMART REPAIR 24

10" - 24"  
RIM STRAIGHTENING MACHINE



**TECHNICAL SPECIFICATIONS**

Rim Diameters	10" - 24"
Hydraulic Engine	0,55kW 900 d/d rpm 1h
Mechanic Engine	NOT INCLUDED
3 phase - single phase	380V -(optional 220V)
Length	1000mm
Width	500mm
Height	1600mm
Weight	160kg
Hydraulic Pump Power	5 ton

**STANDARD ACCESSORIES**



Plastic Tool Holder



1pc Manual Head Repair Tool



3pcs Lengthening Tools



1pc Manuel Gauge Tool



18pcs Rim Centering Adapters



1 Set Piston Holder Adapter



2pcs Allen Keys



5pcs Bolt, Nut and Conical Adapter Set



1 Set Lathe Tool



5pcs Straightening Heads

# RR1 MOTO

10" - 24" MOTORCYCLE  
RIM STRAIGHTENING MACHINE  
WITH LATHE



**TECHNICAL SPECIFICATIONS**

Rim Diameters	10" - 24"
Hydraulic Engine	0,55kW 900 d/d rpm 1h
Mechanic Engine	0,55kW 900 d/d rpm 1h
3 phase - single phase	380V -(optional 220V)
Length	1200mm
Width	800mm
Height	1600mm
Weight	420kg
Hydraulic Pump Power	5 ton

**STANDARD ACCESSORIES**



Plastic Tool Holder



1pc Manual Head Repair Tool



3pcs Lengthening Tools



1pc Manuel Gauge Tool



18pcs Rim Centering Adapters



**SCU 435**  
Speed Control Unit



5pcs Bolt, Nut and Conical Adapter Set



1 Set Lathe Tool



5pcs Straightening Heads



1 Set Piston Holder Adapter



2pcs Allen Keys

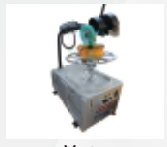

Moto Adapter

**OPTIONAL PARTS**



**MMP90**  
Magnetic Gauge  
Tool Holder



**MMP120**  
Magnetic Gauge



**RR14**  
Motorcycle Rim  
Repair Adapter



**EASY 40**  
Easy Rim Connecting  
Adapter (Connecting Rims  
From Center Cone Without  
Bolts and Nuts 45 - 130 mm)



**PLUG220**  
220V Electric  
Plug Output

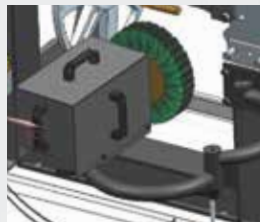

**OCTOP14**  
Additional  
Polishing Adapter



**LAP13**  
Extra Long Press  
Tips Adapter  
**3pcs**



**GLPEN**  
Gold Lathe Pen



**PSSET**  
Polishing Set



**PULL 130**  
Centering Pulley Any  
Special Size (Standarts  
18pcs 54mm-76mm This is  
Ordering For Any Size)



**GVS560**  
Hydraulic Gear  
Valve Set With  
3 Cylinder



**GVS360**  
Hydraulic Gear Valve  
Set With 2 Cylinder

**OPTIONAL PARTS**



**HFM850**  
Steel Halfmoon  
Repair Adapter  
Set 8pcs



**Lathe SET**  
Lathe Set With  
Holders



**DH120**  
Digital  
Thermometer



**HS280**  
Infrared Heating  
System



**OH550**  
Top Frame  
Adapter

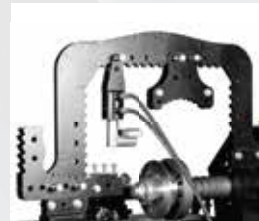

**OH650**  
Pro Type  
Top Frame  
Adapter



**GVS660**  
Hydraulic Gear  
Valve Set With  
4 Cylinder



**SCU**  
Shaft Engine  
Speed Control  
Unit



**HFM250**  
Halfmoon Repair  
Adapter Set 2pcs  
13"-17", 18"-24"

# OPTIONAL PARTS LIST

PARTS CODE	PARTS NAME	RS28 TAB WL PRO	F24 WL PRO	F24 WL	RS28 WL	RS30 WL	F26 WP	RS28 WP	RS26 WL	SMART REPAIR 22	SMART REPAIR 24	RR1 MOTO
Lathe SET	Lathe Set with Holders	✓	✓	✓	✓	✓	✓	✓	✓			✓
DH120	Digital Thermometer	✓				✓						
HS280	Infrared Heating System					✓						
OH550	Top Frame Adapter											
OH650	Pro Type Top Frame Adapter					✓						
GVS360	Hydraulic Gear Vavle Set with 2 Cyclinder											
GVS560	Hydraulic Gear Vavle Set with 3 Cyclinder					✓						
GVS660	Hydraulic Gear Vavle Set with 4 Cyclinder											
SCU	Shaft Engine Speed Control Unit	✓				✓	✓	✓				✓
HFM250	Halfmoon Repair Adapter Set 2 Pcs 13"-17" & 18"-24"	✓	✓			✓						
HFM850	Steel Halfmoon Repair Adapter Set											

# OPTIONAL PARTS LIST

PARTS CODE	PARTS NAME	RS28 TAB WL PRO	F24 WL PRO	F24 WL	RS28 WL	RS30 WL	F26 WP	RS28 WP	RS26 WL	SMART REPAIR 22	SMART REPAIR 24	RR1 MOTO
MMP90	Magnetic Gauge Tool Holder	✓				✓						
MMP120	Magnetic Gauge	✓				✓						
PLUG220	220V Electric Plug Output	✓				✓						
OCTOP14	Additional Polishing Adapter											
RR14	Motorcycle Rim Repair Adapter											✓
EASY40	Easy Rim Connecting Adapter (Connecting Rims from Center Cone without bolts and nuts 4130 mm)					✓						
PULL130	Centering Pulley Any Special Size (Standarts 18 pcs 54mm - 76mm This is for ordering any size)											
LAP13	Extra Long Press Tips Adapter 3 pcs					✓						
GLPEN	Gold Lathe Pen	✓										
PSSET	Polishing Set						✓	✓				
TABPRO1	Tablet System (Pressure Control Unit, Automatic Measure, Wireless Printer, History, User Database, Thermometer and Lathe Program)	✓										

# C32

10" - 32" RIM CLEANING  
AND POLISHING MACHINE



**TECHNICAL SPECIFICATIONS**

Rim Diameters	10" - 32"
Shaft Engine	0,75kW 900 d/d rpm 1h
3 phase - single phase	380V -(optional 220V)
Polishing Engine	2,2kW 2800 d/d rpm 1h
Length	1200mm
Width	800mm
Height	1300mm
Weight	240kg



**STANDARD ACCESSORIES**



Polishing Disc and Cream Medium Type



**SCU 435**  
Speed Control Unit

**OPTIONAL ACCESSORIES**



Truck Adapter



Motorcycle Adapter

# SS3500

## ELECTROHYDRAULIC PLATFORM LIFT

Premium mechanic lock



**TECHNICAL SPECIFICATIONS**

Capacity	3500kg
Lifting height	930mm
Minimum height	110mm
Lifting time	24 sec
3 phase - single phase	380V - (optional 220V)
Length	2000mm
Width	1800mm
Weight	460kg

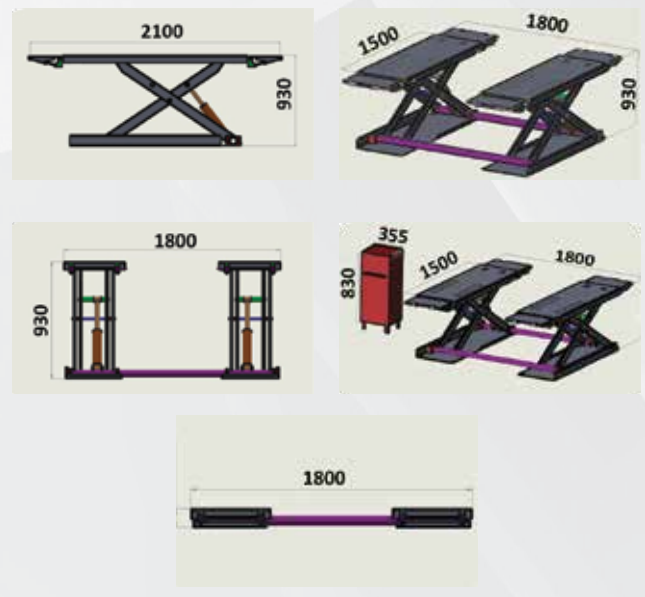

# SS3500 PRO

Mobile Platform Lift With Mechanic Lock

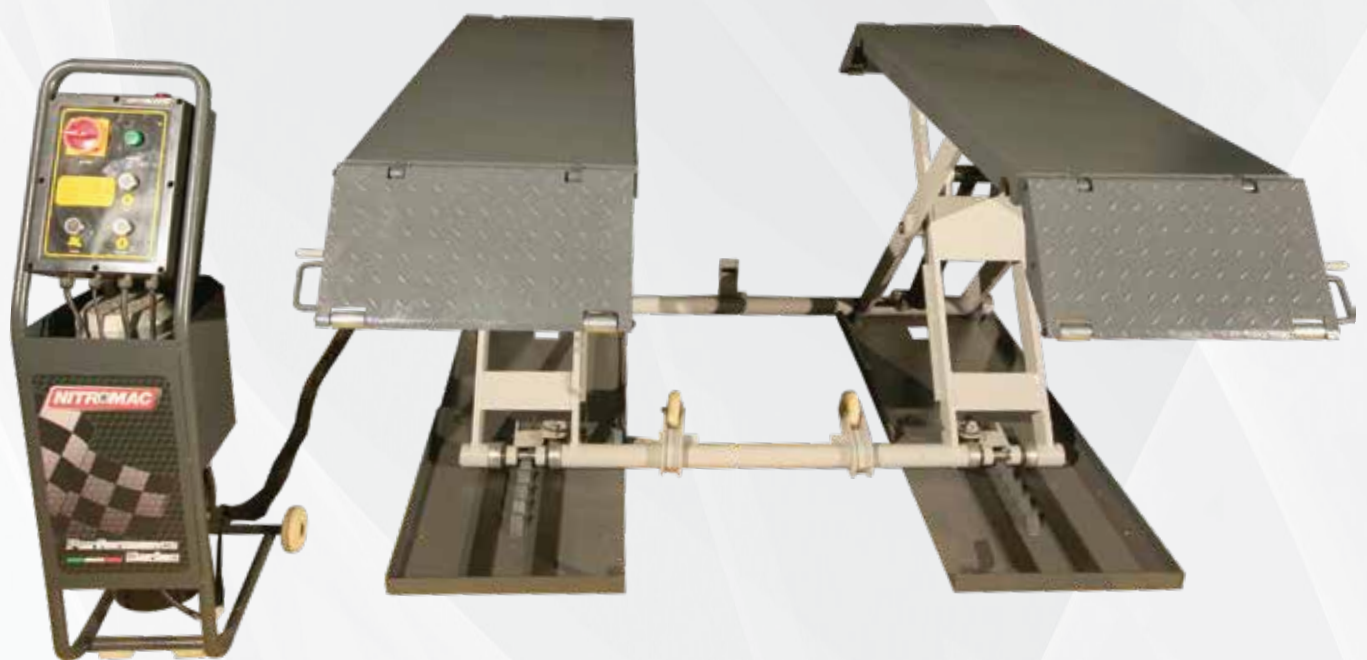

**TECHNICAL SPECIFICATIONS**

Capacity	3500kg
Lifting height	930mm
Minimum height	110mm
Lifting time	24 sec
3 phase - single phase	380V - (optional 220V)
Length	2000mm
Width	1800mm
Weight	460kg

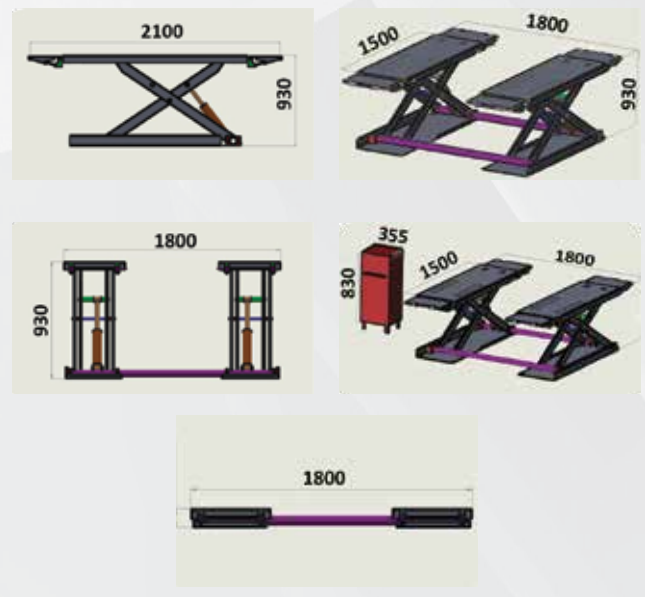

# SL30

## ON-SURFACE SCISSORS LIFT

Hydraulic safety locks system instead of the mechanical safety locks, the S300 is equipped with the safety stop device at the height of 300mm, both control buttons are needed to lower down the lift from 300mm to ground with tone alarm for safety.



### Specifications:

- Lifting capacity: 7,000 lbs.
- Electric-air control operation system.
- Hydraulic self lock system.
- 2-Dual synchronous cylinders are applied to assure the lifting level on both platforms.
- Hydraulic system with dual hydraulic solenoid valve control to assure the lowering speed would not be affected by the loading weight.
- Low profile design, the lowest height is only 115mm.
- The safety stop device at the height of 300mm, both control buttons are needed to lower down the lift from 300mm to ground with tone alarm for safety.

**TECHNICAL SPECIFICATIONS**

Capacity	3500kg
Lifting height	2000mm
Minimum height	115mm
Lifting time	24 sec
3 phase - single phase	380V - (optional 220V)
Length	2028mm
Width	2030mm
Weight	660kg

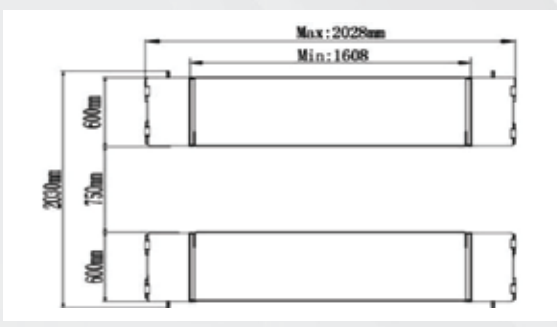
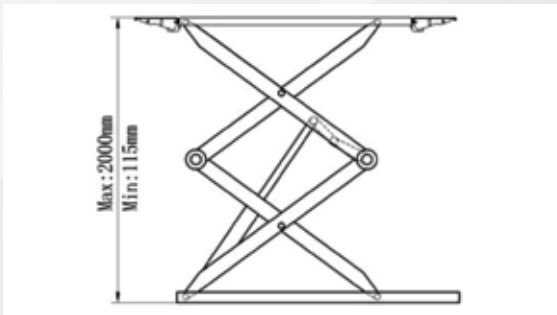

# SL550

## ALIGNMENT SCISSORS LIFT

This S350F is a true space-saving scissors car lift, when you don't use the lift, it just hide into the ground. Unobstructed access points for easy entry and exit front, rear and both sides to increase work space below the lift and around the runways. The Lift of platforms are designed to be extended, it is suited for most of cars.



### Specifications:

- 2-dual synchro• Lifting capacity: 12,000 lbs.
- Dual synchronous cylinders are applied to ensure the lifting level on both runways.
- Adjustable locking bars. Each locking is adjusted by screw, and it is easily to level the runways.
- Mechanical safety device. A simple foot operated safety lock release is Located on either side of the lift for operator convenience. The safety locks engage automatically anytime the lift is raised.
- Maximum strength: The X serial scissors lifts use 150\*75 tube and adding two additional reinforcement "ribs" underneath each runway, this assures that the runways remain level during alignment process.
- Integrated rear slip-plates.
- Electric/Hydraulic power system. The system is operated by easily control.nal Jack and Turnplate.

**TECHNICAL SPECIFICATIONS**

Capacity	5500kg
Lifting height	1870mm
Minimum height	300mm
Lifting time	44 sec
3 phase - single phase	380V - (optional 220V)
Length	5018mm
Width	2290mm
Weight	1570kg

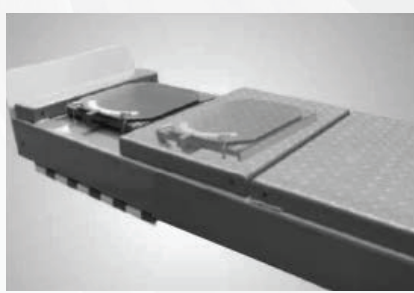
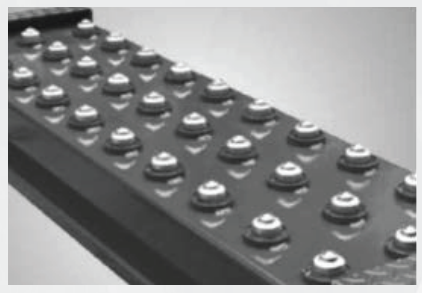
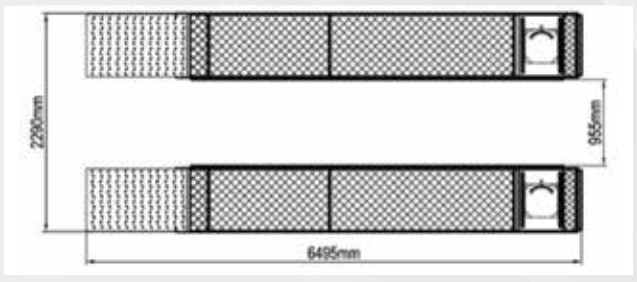
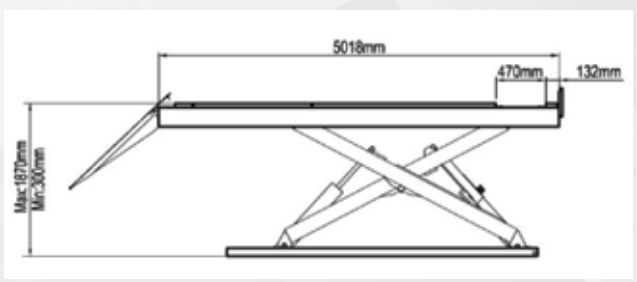

# SL40

## WIDER & STRONGER MODEL FLOORPLATE CHAIN-DRIVED LIFT

Nitromac introduces a revolutionary double lock system installed in both columns. This new lock system incorporates two locking mechanisms for added safety. The double lock system is automatically activated as the lift is raised.



### Specifications:

- Lifting capacity: 9,000lbs.
- Electrical control operation system, high limit device.
- Dual hydraulic cylinders, designed and made on US standard, high quality NOK seals.
- Every cylinder has passed the 25Mpa test.
- Super symmetric arms design with three-stages front arms and two-stages rear arms. Symmetrical or asymmetrical lifting function, suitable for all kinds of vehicles.
- Screw and stackable adapters design of rubber pad with 3" Stackable adapters to adjust the lowest height in speedy. • Automatic arms restraints.
- Self-lubricating UHMW Polyethylene sliders and bronze bush.
- Single-point safety release, and dual safety design.
- 3/8" aircraft quality cable is used for synchronization.

**TECHNICAL SPECIFICATIONS**

Capacity	4500kg
Lifting height	2095mm
Minimum height	100mm
Lifting time	65 sec
3 phase - single phase	380V - (optional 220V)
Length	3060mm
Width	2850mm
Weight	460kg

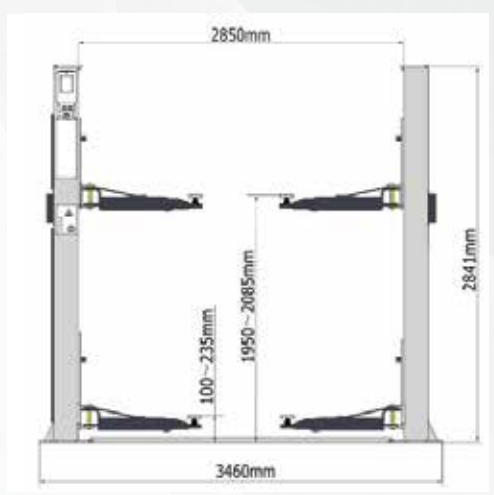

# SS500

ELECTROHYDRAULIC SCISSORS  
PLATFORM LIFT



Optional Cover

**TECHNICAL SPECIFICATIONS**

Capacity	500kg
Lifting height	930mm
Minimum height	150mm
Lifting time	24 sec
3 phase - single phase	380V - (optional 220V)
Lengt	2200mm
Width	800mm
Weight	260kg

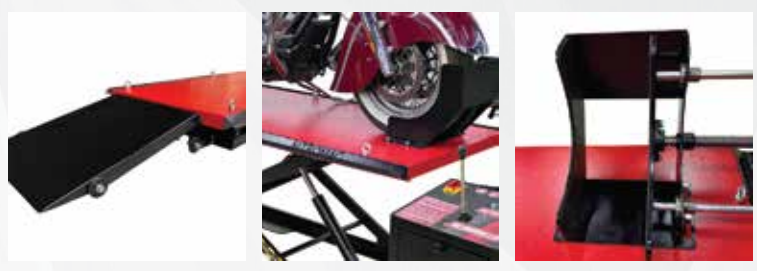

# SS750pro

ELECTROHYDRAULIC SCISSORS  
PLATFORM LIFT



Optional Cover

**TECHNICAL SPECIFICATIONS**

Capacity	750kg
Lifting height	930mm
Minimum height	150mm
Lifting time	24 sec
3 phase - single phase	380V - (optional 220V)
Length	2200mm
Width	800mm
Weight	320kg



# HD TEST

## HEADLIGHT TESTER WITH LASER

### TECHNICAL SPECIFICATIONS

- Digital Screen
- LDR Sonar
- Ultra Stream Laser
- Laser Measuring
- PL Lens
- 9V DC Battery
- Slide Off Lock System



# HD TEST PRO

HEADLIGHT TESTER WITH LASER

## TECHNICAL SPECIFICATIONS

- Digital Screen
- LDR Sonar
- Ultra Stream Twin Laser
- 2 Pcs Laser Measuring
- PL Lens
- 9V DC Battery
- Slide Off Lock System



# R8

## NITROGEN GAS INFLATOR

### TECHNICAL SPECIFICATIONS

6m <sup>3</sup> per hour of Nitrogen capacity	-
Nitrogen Purity	87%-92%
Air Compressor required	8-10 kg
N2 outlet pressure	0-8 kg/cm <sup>2</sup>
N2 generating speed	35-55 l/min
Rating input voltage	220V
Dimensions	48x50x125h
Packing size	30x30x115h
Weight	35 kg



# Tyre Changers



# PS24Y

## 12" - 24" SEMI AUTOMATIC TYRE CHANGER

**TECHNICAL SPECIFICATIONS**

Clamping Capacity	12" -24"
Max. Wheel Weight	75kg
Max. Wheel Diameter	43"
Hydraulic Unit Motor	1,1kw / 380V (optional 220V)
Rotation Speed	6 - 16 rpm
Operating Pressure	8 - 10 bar
Bead Breaker Force	6000 N horizontal-3000 N vertical arm
Packing Dimensions	1150x1000x1900h mm
Gross Weight	225kg



# NT24Y

## 12" - 24" SEMI AUTOMATIC TYRE CHANGER

### TECHNICAL SPECIFICATIONS

Clamping Capacity	12" -24"
Max. Wheel Weight	75kg
Max. Wheel Diameter	43"
Hydraulic Unit Motor	1,1kw / 380V (optional 220V)
Rotation Speed	6 - 16 rpm
Operating Pressure	8 - 10 bar
Bead Breaker Force	6000 N horizontal-3000 N vertical arm
Packing Dimensions	1150x1000x1900h mm
Gross Weight	225kg



# MOTO24Y

12" - 24" SEMI AUTOMATIC TYRE CHANGER



**TECHNICAL SPECIFICATIONS**

Clamping Capacity	12" -24"
Max. Wheel Weight	75kg
Max. Wheel Diameter	43"
Hydraulic Unit Motor	1,1kw / 380V (optional 220V)
Rotation Speed	6 - 16 rpm
Operating Pressure	8 - 10 bar
Bead Breaker Force	6000 N horizontal-3000 N vertical arm
Packing Dimensions	1150x1000x1900h mm
Gross Weight	225kg

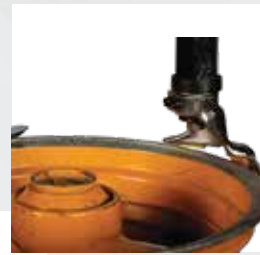

# PS26

## 9" - 26" NEW MODEL AUTOMATIC TYRE CHANGER

### Specifications:

Tilt-back tyre changer with right helper arm

The streamlined design makes machine more attractive

Composite body designed to reduce wobble Aluminum valve  
with stainless rod

Bead breaker cylinder with tower spring

Drawer pedal assembly makes after  
sale service easier



optional blaster

**TECHNICAL SPECIFICATIONS**

Clamping Capacity	9" -26"
Max. Wheel Weight	75kg
Max. Wheel Diameter	43"
Hydraulic Unit Motor	1,1kw / 380V (optional 220V)
Rotation Speed	6 - 16 rpm
Operating Pressure	8 - 10 bar
Bead Breaker Force	6000 N horizontal-3000 N vertical arm
Packing Dimensions	1150x1000x1900h mm
Gross Weight	265kg



**STANDARD ACCESSORIES**

- Embedded plastic cover for clamping jaws. Protect rim from damage and sliding. Demounting head is made of 2Cr13 materials with good performance.
- Reset spring makes operation easier.
- 380V two-speed motor make work more efficient
- Casting support of turn table cylinder with better structure and performance.
- Bead breaker cylinder with tower-type spring makes breaking more powerful.
- Washer for the demount head, Embedded cover for clamping jaw Cover for bead braker. Avoid damage to the rims.
- More convenient to work with right helper arm.
- New designed lever according to human engineering.
- Helper arm has the third press point and could work with run-flat and low-profile tyres.

# PS26R

## 9" - 26" NEW MODEL AUTOMATIC TYRE CHANGER

### Specifications:

Tilt-back tyre changer with right helper arm

The streamlined design makes machine more attractive

Composite body designed to reduce wobble Aluminum valve  
with stainless rod

Bead breaker cylinder with tower spring

Drawer pedal assembly makes after  
sale service easier



optional blaster

## TECHNICAL SPECIFICATIONS

Clamping Capacity	9" -26"
Max. Wheel Weight	75kg
Max. Wheel Diameter	43"
Hydraulic Unit Motor	1,1kw / 380V (optional 220V)
Rotation Speed	6 - 16 rpm
Operating Pressure	8 - 10 bar
Bead Breaker Force	6000 N horizontal-3000 N vertical arm
Packing Dimensions	1150x1000x1900h mm
Gross Weight	295kg



## STANDARD ACCESSORIES

Embedded plastic cover for clamping jaws. Protect rim from damage and sliding.

Demounting head is made of 2Cr13 materials with good performance. Reset spring makes operation easier.

380V two-speed motor make work more efficient

Casting support of turn table cylinder with better structure and performance.

Bead breaker cylinder with tower-type spring makes breaking more powerful.

Washer for the demount head, Embedded cover for clamping jaw Cover for bead breaker. Avoid damage to the rims.

More convenient to work with right helper arm.

New designed lever according to human engineering.

Helper arm has the third press point and could work with run-flat and low-profile tyres.

# NB26R

## 9" - 26" NEW MODEL AUTOMATIC TYRE CHANGER

### Specifications:

Tilt-back tyre changer with right helper arm

The streamlined design makes machine more attractive

Composite body designed to reduce wobble Aluminum valve  
with stainless rod

Bead breaker cylinder with tower spring

Drawer pedal assembly makes after  
sale service easier



## TECHNICAL SPECIFICATIONS

Clamping Capacity	9" -26"
Max. Wheel Weight	75kg
Max. Wheel Diameter	43"
Hydraulic Unit Motor	1,1kw / 380V (optional 220V)
Rotation Speed	6 - 16 rpm
Operating Pressure	8 - 10 bar
Bead Breaker Force	6000 N horizontal-3000 N vertical arm
Packing Dimensions	1150x1000x1900h mm
Gross Weight	295kg

## STANDARD ACCESSORIES

Embedded plastic cover for clamping jaws. Protect rim from damage and sliding.

Demounting head is made of 2Cr13 materials with good performance. Reset spring makes operation easier.

380V two-speed motor make work more efficient

Casting support of turn table cylinder with better structure and performance.

Bead breaker cylinder with tower-type spring makes breaking more powerful.

Washer for the demount head, Embedded cover for clamping jaw Cover for bead braker. Avoid damage to the rims.

More convenient to work with right helper arm.

New designed lever according to human engineering.

Helper arm has the third press point and could work with run-flat and low-profile tyres.

# NT28

## 9" - 28" NEW MODEL AUTOMATIC TYRE CHANGER

### Specifications:

Tilt-back tyre changer with right helper arm

The streamlined design makes machine more attractive

Composite body designed to reduce wobble Aluminum valve  
with stainless rod

Bead breaker cylinder with tower spring

Drawer pedal assembly makes after  
sale service easier



**TECHNICAL SPECIFICATIONS**

Clamping Capacity	9" -28"
Max. Wheel Weight	75kg
Max. Wheel Diameter	43"
Hydraulic Unit Motor	1,1kw / 380V (optional 220V)
Rotation Speed	6 - 16 rpm
Operating Pressure	8 - 10 bar
Bead Breaker Force	6000 N horizontal-3000 N vertical arm
Packing Dimensions	1150x1000x1900h mm
Gross Weight	325kg



**STANDARD ACCESSORIES**

- Embedded plastic cover for clamping jaws.
- Protect rim from damage and sliding.
- Demounting head is made of 2Cr13 materials with good performance.
- Reset spring makes operation easier.
- 380V two-speed motor make work more efficient
- Casting support of turn table cylinder with better structure and performance.
- Bead breaker cylinder with tower-type spring makes breaking more powerful.
- Washer for the demount head, Embedded cover for clamping jaw Cover for bead braker. Avoid damage to the rims.
- More convenient to work with right helper arm.
- New designed lever according to human engineering.
- Helper arm has the third press point and could work with run-flat and low-profile tyres.



# NT28R

## 9" - 28" NEW MODEL AUTOMATIC TYRE CHANGER

### Specifications:

Tilt-back tyre changer with right helper arm

The streamlined design makes machine more attractive

Composite body designed to reduce wobble Aluminum valve  
with stainless rod

Bead breaker cylinder with tower spring

Drawer pedal assembly makes after  
sale service easier



## TECHNICAL SPECIFICATIONS

Clamping Capacity	9" -28"
Max. Wheel Weight	75kg
Max. Wheel Diameter	43"
Hydraulic Unit Motor	1,1kw / 380V (optional 220V)
Rotation Speed	6 - 16 rpm
Operating Pressure	8 - 10 bar
Bead Breaker Force	6000 N horizontal-3000 N vertical arm
Packing Dimensions	1150x1000x1900h mm
Gross Weight	345kg



## STANDARD ACCESSORIES

Embedded plastic cover for clamping jaws. Protect rim from damage and sliding. Demounting head is made of 2Cr13 materials with good performance.

Reset spring makes operation easier.

380V two-speed motor make work more efficient

Casting support of turn table cylinder with better structure and performance.

Bead breaker cylinder with tower-type spring makes breaking more powerful.

Washer for the demount head, Embedded cover for clamping jaw Cover for bead braker. Avoid damage to the rims.

More convenient to work with right helper arm.

New designed lever according to human engineering.

Helper arm has the third press point and could work with run-flat and low-profile tyres.



# NT1430

## Specifications:

Two speed hydraulic chuck  
with 5 different rim locking positions, mobile control unit  
with anti-crush cable and military plug.

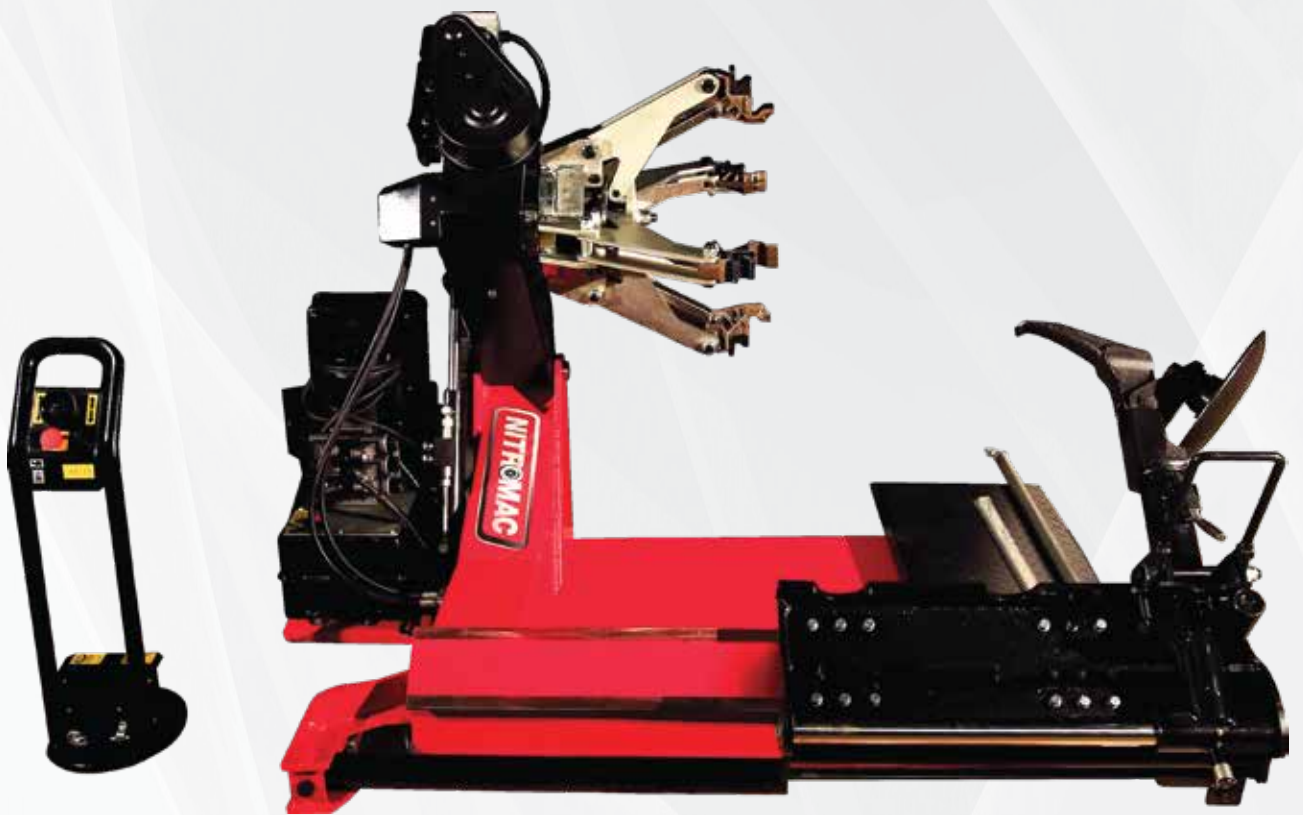

**TECHNICAL SPECIFICATIONS**

Clamping Capacity	14" -30"
Max. Wheel Weight	1500 kg
Max. Wheel Diameter	63"
Hydraulic Unit Motor	1,5kw / 380V
Rotation Speed	6 - 16 rpm
Operating Pressure	0 - 130 bar
Bead Breaker Force	1865 kg
Packing Dimensions	1500x1600x1050h mm
Gross Weight	630kg

**STANDARD ACCESSORIES**

- Rim lever
- Bead lifting lever
- Rim pliers

**OPTIONAL ACCESSORIES**

- Pliers for alloy rims
- Jaw protections for alloy rims

# NT1456

## Specifications:

Two speed hydraulic chuck  
with 5 different rim locking positions, mobile control unit  
with anti-crush cable and military plug.



## TECHNICAL SPECIFICATIONS

Clamping Capacity	14" -56"
Max. Wheel Weight	1500 kg
Max. Wheel Diameter	63"
Hydraulic Unit Motor	1,5kw / 380V
Rotation Speed	6 - 16 rpm
Operating Pressure	0 - 130 bar
Bead Breaker Force	1865 kg
Packing Dimensions	1500x1600x1050h mm
Gross Weight	630kg

## STANDARD ACCESSORIES

Rim lever

Bead lifting lever

Rim pliers

## OPTIONAL ACCESSORIES

Pliers for alloy rims

Jaw protections for alloy rims

# S2000

## WHEEL BALANCER

**TECHNICAL SPECIFICATIONS**

Truck , bus, pick - up capacity	5000kg
Car, pick-up capacity	800kg
RPM of drive disk	3000 rpm
Balancing speed	85-175 km/h



# MOT024

## 10" - 24" WHEEL BALANCING MACHINE

### TECHNICAL SPECIFICATIONS

Wheel	10" -24"
Max. Wheel Weight	65kg
Rim width setting range	1,5" - 20"
Balancing time	8sn
Balancing speed	200 rpm
Measurement Uncertainty	1 g
Power Supply	220V/230V, 50/60 Hz.



# MOTO24 BALANCER PRO

10" - 24"  
WHEEL BALANCING MACHINE



## TECHNICAL SPECIFICATIONS

Wheel	10" -24"
Max. Wheel Weight	65kg
Rim width setting range	1,5" - 20"
Balancing time	8sn
Balancing speed	200 rpm
Measurement Uncertainty	1 g
Power Supply	220V/230V, 50/60 Hz.

# NB800

10" - 30"

**WHEEL BALANCING MACHINE WITH 17" TFT  
FLAT SCREEN**

## Specifications:

- New ergonomic, easy-use and essential design
- WBA Wheel Best Access: Wide space to work inside the rim
- VDD Virtual Direct Drive - very quick and maintenance free measurement system

(Patented)

- Lock of wheel in the correction position by means of an electromagnetic brake - Software programs for the professionals: SPLIT, OPT, ALU
- Extended gauge for diameter and distance measurement of rims up to 28" with new pincer to hold the adhesive weight
- ALU-S balancing mode (adhesive weights on the internal rim planes) with specific counterweight position indicator (position repeater)
- LASER for weight positioning inside the rim
- 17" TFT flat screen



MANUAL LOCKING



**TECHNICAL SPECIFICATIONS**

Wheel	10" -30"
Max. Wheel Weight	65kg
Max. absorbed power	0,15 kw
Balance time	4,7 sec
Balancing speed	100 rpm
Measurement Uncertainty	0,5 g
Power Supply	220V/230V, 50/60 Hz.

**STANDARD ACCESSORIES**

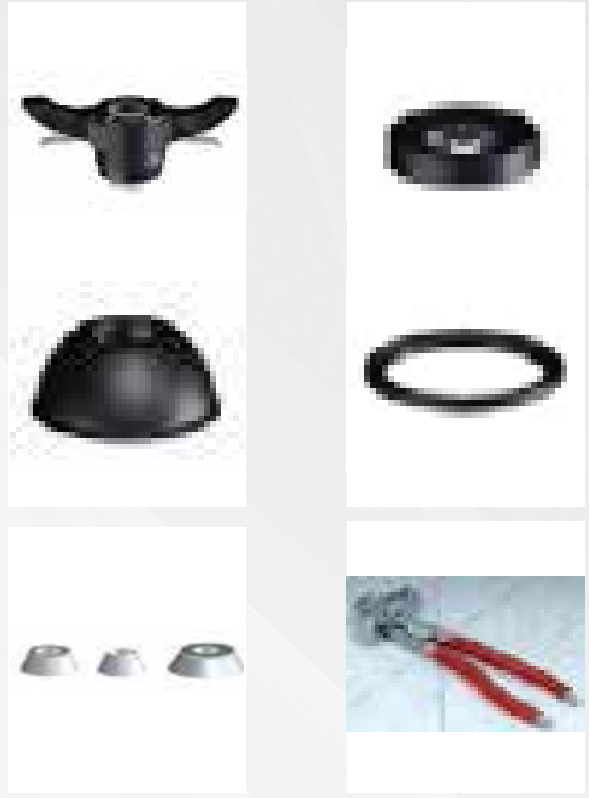

# NB900Pro S

10" - 30"

WHEEL BALANCING MACHINE WITH 17" TFT  
FLAT SCREEN

## Specifications:

- New ergonomic, easy-use and essential design
- WBA Wheel Best Access: Wide space to work inside the rim
- VDD Virtual Direct Drive - very quick and maintenance free measurement system (Patented)
- Lock of wheel in the correction position by means of an electromagnetic brake
- Software programs for the professionals: SPLIT, OPT, ALU
- Extended gauge for diameter and distance measurement of rims up to 28" with new pincer to hold the adhesive weight
- ALU-S balancing mode (adhesive weights on the internal rim planes) with specific counterweight position indicator (position repeater) - LASER for weight positioning inside the rim
- 17" TFT flat screen



PNEUMATIC LOCKING

**TECHNICAL SPECIFICATIONS**

Wheel	10" -30"
Max. Wheel Weight	65kg
Max. absorbed power	0,15 kw
Balance time	4,7 sec
Balancing speed	100 rpm
Measurement Uncertainty	0,5 g
Power Supply	220V/230V, 50/60 Hz.





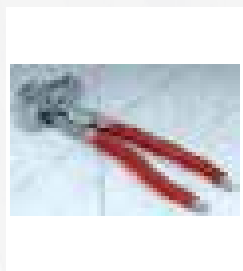
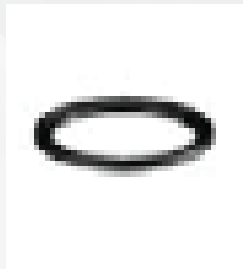
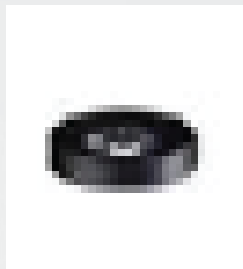









**STANDARD ACCESSORIES**



# AIR COMPRESSOR 500



## TWO STAGE PISTON AIR COMPRESSORS

Code															
	Stationary	Lt/min	CFM	M/h	Kw	Hp	Pump	Cylinder	RPM	Voltage	Far	Bar	PSI	X x Y x Z mm	Kg
SET 40/200-4	200	514	18.20	30.84	3	4	4900	2	1425	400	3	12	159	1330x610x1060	112
SET 40/200-4MP	200	514	18.20	30.84	3	4M	4900	2	1425	230	1	12	159	1330x610x1060	112
SET 40/200-5.5P	200	520	18.41	31.2	4	5.5	4900	2	1425	400	3	12	159	1330x610x1060	112
SET 40/300-4	300	514	18.20	30.84	3	4	4900	2	1425	400	3	12	159	1680x500x1030	165
SET 40/300-5.5P	300	520	18.41	31.2	4	5.5	4900	2	1425	400	3	12	159	1680x500x1030	170
SET 40/300-4MP	200	514	18.20	30.84	3	4	4900	2	1425	230	1	12	159	1680x500x1030	165
SET 40/400-4	200	514	18.20	30.84	3	4	4900	2	1425	400	3	12	159	1650x650x1250	210
SET 40/400-4MP	200	514	18.20	30.84	3	4	4900	2	1425	230	1	12	159	1650x650x1250	210
SET 40/400-5.5P	200	520	18.41	31.2	4	5.5	4900	2	1425	400	3	12	159	1650x650x1250	215
SET 50/500-5.5P	200	653	23.12	39.18	4	5.5	5900	2	1160	400	3	12	159	1950x650x1250	230
SET 50/500-7.5P	200	700	24.78	42	5.5	7.5	5900	2	1160	400	3	12	159	1950x650x1250	230
SET 60/500-7.5P	200	827	29.28	49.62	5.5	7.5	6000	2	1325	400	3	12	159	1950x650x1250	235
SET 50/500-10P	200	860	30.44	51.6	7.5	10	6000	2	1325	400	3	12	159	1950x650x1250	235
SET 70/500-10P	200	1210	42.83	72.6	7.5	10	7000	2	1160	400	3	12	159	1950x650x1300	250
SET 70/500-15YP	200	1410	49.91	84.6	11	15	7000	2	1300	400	3	12	159	1950x650x1300	260
SET 2x50 / 750-2x5.5P	200	1306	46.23	78.36	2x4	2x5.5	2x5900	4	1160	400	3	12	159	2700x650x1300	420
SET 2x60 / 750-2x7.5P	200	1654	58.55	99.24	2x5.5	2x7.5	2x6000	4	1325	400	3	12	159	2700x650x1300	440

# TANK MOUNTED AIR SCREW COMPRESSORS

MODEL	7,5 Bar	7,5 Bar	7,5 Bar	MOTOR		CONNECTION	TANK	DECIBEL	SIZE (mm)			WEIGHT
	L/min	L/min	L/min	HP	kW	(G")	LITRE	Db (A)	X	Y	Z	(kg)
SVK 7,5-T	870	690	560	7,5	5,5	3/4	500	65	660	1900	1500	370
SVK 10-T	1050	910	810	10	7,5	3/4	500	65	660	1900	1500	380
SVK 15-T	1750	1400	1100	15	11	3/4	500	65	770	1900	1600	390
SVK 20-T	2050	1850	1600	20	15	3/4	500	65	770	1900	1600	400
SVK 7,5-TK	870	690	560	7,5	5,5	3/4	500	65	660	1900	1500	400
SVK 10-TK	1050	910	810	10	7,5	3/4	500	65	660	1900	1500	411
SVK 15-TK	1750	1400	1100	15	11	3/4	500	65	770	1900	1600	422
SVK 20-TK	2050	1850	1600	20	15	3/4	500	65	770	1900	1600	432



# AUTOMECHANICA ISTANBUL/TURKEY

- 2012
- 2013
- 2014
- 2015
- 2016
- 2017
- 2018



# AUTOMECHANICA FRANKFURT / GERMANY

- 2012
- 2014
- 2016
- 2018



# AUTOPROMOTEC BOLOGNA / ITALY

- 2013
- 2015
- 2017

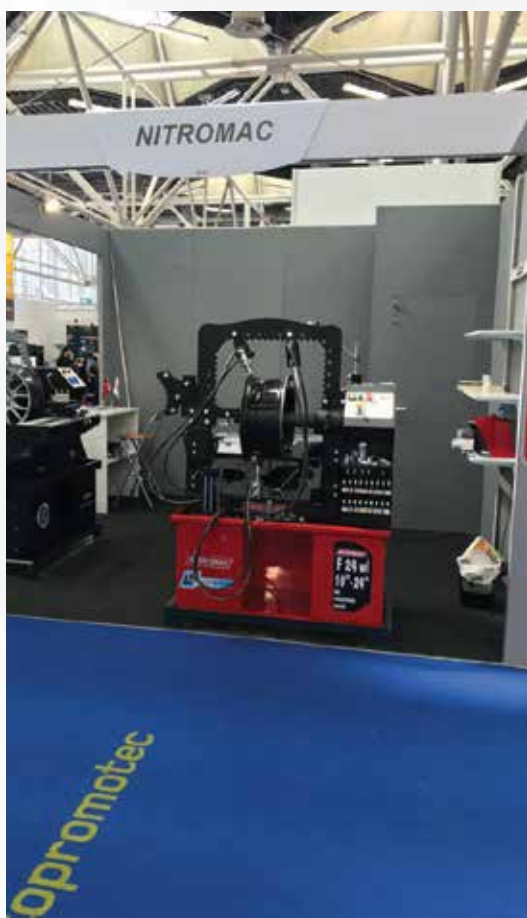

# SEMA LAS VEGAS / U.S.A.

- 2012
- 2013
- 2014
- 2015
- 2016
- 2017
- 2018





**Nitromak Servis Ekipmanları İthalat İhracat Makina Sanayi ve Ticaret Limited Şirketi**  
Kaklıç Mah. 10302 Sok. No: 9 Çiğli / İZMİR / TÜRKİYE

Jant düzeltme ve parlatma makinaları, rot ve balans makinaları,  
otomotiv servis ekipmanları imalatı ve satışı.  
*Manufacturing and sales of wheel straightening and polishing machines,  
rod and balancing machines, automotive service equipments*

**TS ISO 45001:2018**  
**İş Sağlığı ve Güvenliği Yönetim Sistemi**  
*Occupational Health and Safety Management System*

Kuruluşun yönetim sisteminin, Mrtssystem Denetçi ve Baş Denetçileri tarafından yapılan incelemeler sonucunda, belirtilen faaliyet kapsamında ilgili standart şartlarını karşıladığı gözlemlenmiştir. Bu sertifika, sözleşme şartlarına ve Mrtssystem prosedürlerine uyulduğu sürece geçerlidir.  
*The organization's management system, as a result of audits conducted by the Mrtssystem Auditors and Lead Auditors under the specified activity has been observed to meet the standard requirements. This certificate is valid as long as the terms of the contract and Mrtssystem procedures are followed.*

İlk Yayın Tarihi | First Issue Date  
27 Kasım 2019

Geçerlilik Tarihi | Expiry Date  
26 Kasım 2022

Sertifikasyon Periyodu | Certification Period  
3 Yıl | 3 Year

Murat Karagözü  
Genel Müdür | General Manager

İsmet Kaptan Mah.  
Hürriyet Bv. No: 3/1 Daire: 22  
Konak | İZMİR | TÜRKİYE

+90 532 111 5 678  
info@mrtssystem.com.tr

mrtssystem.com.tr

00/00.00.00





# Certificate

## CE

CE ATTESTATION OF CONFORMITY

**Manufacture Name / İmalatçı Adı:** NİTROMAK SERVİS EKİPMANLARI İTHALAT İHRACAT MAKİNA SANAYİ VE TİCARET LİMİTED ŞİRKETİ

**Address / Adres:** KARLIÇ MAH. 10302. SOK. NO:9 ÇİĞLİ / ÜZMİR / TÜRKİYE

The product groups defined below have been fulfilled and the responsibility of the applicable requirements of Machine Safety Directive 2006/42/EC has been accepted by NİTROMAK SERVİS EKİPMANLARI İTHALAT İHRACAT MAKİNA SANAYİ VE TİCARET LİMİTED ŞİRKETİ. The product groups defined below are subject to internal production controls, depending on NİTROMAK SERVİS EKİPMANLARI İTHALAT İHRACAT MAKİNA SANAYİ VE TİCARET LİMİTED ŞİRKETİ. It has been checked by: In this context, it belongs to the company where the responsibility is fulfilled.

Aşağıda tanımlanan olan ürün grupları Makine Emniyeti Yönetmeliği 2006/42/AT'nin uygulanabilen gerekliliklerinin yerine getirildiği ve sorumluluğundan alınmış olduğunu NİTROMAK SERVİS EKİPMANLARI İTHALAT İHRACAT MAKİNA SANAYİ VE TİCARET LİMİTED ŞİRKETİ tarafından kabul edilmiştir. Aşağıda tanımlanan ürün grupları, iç üretim kontrollerine bağlı olarak NİTROMAK SERVİS EKİPMANLARI İTHALAT İHRACAT MAKİNA SANAYİ VE TİCARET LİMİTED ŞİRKETİ tarafından kontrol edilmiştir. Bu kapsamda sorumluluğundan yerine getirildiği firmaya aittir.

**Description of Product / Ürün Tanımı:**  
ELECTRO-HYDRAULIC SCISSOR PLATFORM LIFT  
ELEKTRİ-HİDROLİK MAKASLI PLATFORM LİFT

**Product Model / Ürün Modeli:**  
SL30

**Trade Mark / Ticari Marka:**  
NITROMAC

**Related Directives / İlgili Yönetmelikler:**  
MACHINE SAFETY DIRECTIVE 2006/42/EC  
MACHINE EMNİYETİ YÖNETMELİĞİ 2006/42/AT

**Certificate Number :** CE/25528  
**Certificate Issue Date :** 25.02.2022  
**Certificate Validity :** 24.02.2023



Certificate of validity information: E-mail: info@nitromac.com  
info@nitromac.com



# Certificate

## CE

CE ATTESTATION OF CONFORMITY

**Manufacture Name / İmalatçı Adı:** NİTROMAK SERVİS EKİPMANLARI İTHALAT İHRACAT MAKİNA SANAYİ VE TİCARET LİMİTED ŞİRKETİ

**Address / Adres:** KARLIÇ MAH. 10302. SOK. NO:9 ÇİĞLİ / ÜZMİR / TÜRKİYE

The product groups defined below have been fulfilled and the responsibility of the applicable requirements of Machine Safety Directive 2006/42/EC has been accepted by NİTROMAK SERVİS EKİPMANLARI İTHALAT İHRACAT MAKİNA SANAYİ VE TİCARET LİMİTED ŞİRKETİ. The product groups defined below are subject to internal production controls, depending on NİTROMAK SERVİS EKİPMANLARI İTHALAT İHRACAT MAKİNA SANAYİ VE TİCARET LİMİTED ŞİRKETİ. It has been checked by: In this context, it belongs to the company where the responsibility is fulfilled.

Aşağıda tanımlanan olan ürün grupları Makine Emniyeti Yönetmeliği 2006/42/AT'nin uygulanabilen gerekliliklerinin yerine getirildiği ve sorumluluğundan alınmış olduğunu NİTROMAK SERVİS EKİPMANLARI İTHALAT İHRACAT MAKİNA SANAYİ VE TİCARET LİMİTED ŞİRKETİ tarafından kabul edilmiştir. Aşağıda tanımlanan ürün grupları, iç üretim kontrollerine bağlı olarak NİTROMAK SERVİS EKİPMANLARI İTHALAT İHRACAT MAKİNA SANAYİ VE TİCARET LİMİTED ŞİRKETİ tarafından kontrol edilmiştir. Bu kapsamda sorumluluğundan yerine getirildiği firmaya aittir.

**Description of Product / Ürün Tanımı:**  
ELECTRO-HYDRAULIC SCISSOR VEHICLE LIFT  
ELEKTRİ-HİDROLİK İLE MAKASLI ARAÇ KALDIRMA LİFTİ

**Product Model / Ürün Modeli:**  
SS500 / SS750 / SS3000 / SS3500

**Trade Mark / Ticari Marka:**  
NITROMAC

**Related Directives / İlgili Yönetmelikler:**  
MACHINE SAFETY DIRECTIVE 2006/42/EC  
MACHINE EMNİYETİ YÖNETMELİĞİ 2006/42/AT

**Regulations Applied acc. To Harmonized Standards / Uygulanan Uyumlaştırılmış Standartlar:**  
TS EN 1570-1, EN ISO 12100:2010, EN 60204-1

**Certificate Number :** CE/19762  
**Certificate Issue Date :** 07.11.2019  
**Certificate Validity :** 06.11.2022



Certificate of validity information: E-mail: info@nitromac.com  
info@nitromac.com



### **FACTORY**

10302 sk. İzmir Caddesi No:9 Kaklıç Çiğli İzmir TURKEY

Phone: +90 232 325 90 90

Fax: +90 232 325 00 50

E-Mail: [info@nitromac.com](mailto:info@nitromac.com)